

REPLACEMENT PART DESCRIPTION FORM

MODEL #: B386-81,97

PART#	DESCRIPTION	USED ON:	MRP#	FOB \$	MATERIAL	QTY.	FACTORY USE ONLY!!	
							PACK	P/M
1	Headboard Post (995x85x45mm)	B386-81	R84215		Wood	2	F	M
2	Side Rail (w/Hooks)(L=2085mm)	B386-97	R84217		Wood	2	K	M
3	Slat Assembly (w/T-Nut)(L=1542mm)/14pcs	B386-81	R84233		Wood	1	K	M
4	Center Support Rail (L=1925mm)	B386-97	R84220		Wood	1	F	M
5	Center Leg (w/Bolt+Leveler)(280x30x30mm)	B386-81	R84222		Wood	4	G	M
6	Hook #1 (w/Screws)	B386-97	R78852		Metal	2	G	P
7	Hook #2 (w/Screws)	B386-97	R78853		Metal	2	G	P
8	D-Nut (5/16in x 15mm)	B386-81	R76141		Metal	4	G	P
9	D-Nut (5/16in x 20mm)	B386-81	R46219		Metal	12	G	P
10	T-Nut (5/16in x 20mm)	B386-81	R84225		Metal	4	G	P
11	Adjustable Leveler (M6x26mm)(D=32mm)	B386-81	R84226		Metal+Plastic	4	G	P
12	Touch Button (w/Screw+Washer)	B386-81	R84227		Metal	2	G	P
13	Power Adapter	B386-81	R84228		Plastic	1	G	P
14	LED Strip	B386-81	R84229		Plastic	1	G	P
15	Control Box	B386-81	R84230		Plastic	1	G	P
16	Hardware Pack	B386-81	R84232		5/16inx1 3/4 in Allen Bolt (8) 5/16in x 3/4in Allen Bolt (8) 5/16in Flat Washer (16) 5/16in Lock Washer (16) #8 x 1 1/4in Pan Head Screw (8) #4 Allen Key (1)	1	G	P

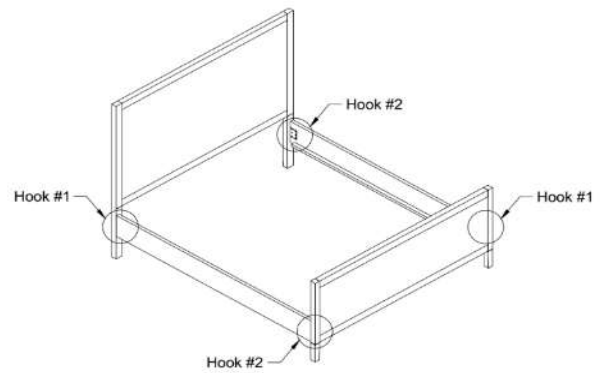
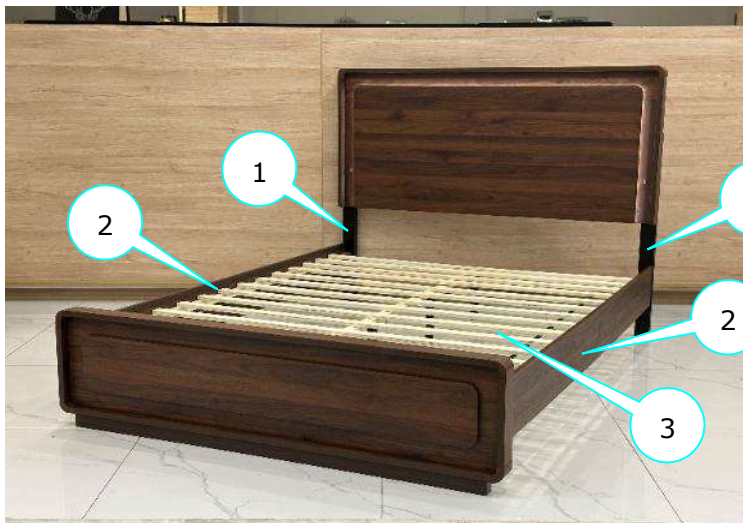

REPLACEMENT PART DESCRIPTION FORM
MODEL #: B386-81,97

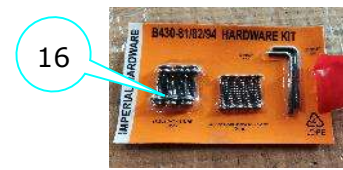
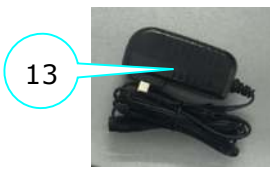
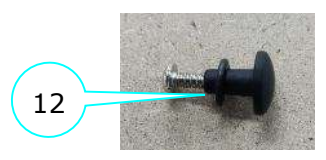
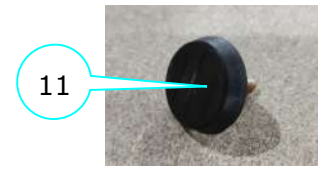
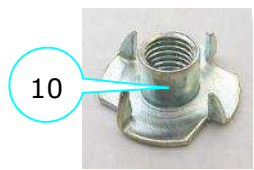
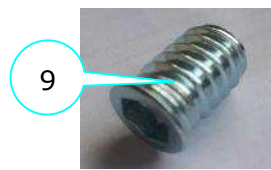
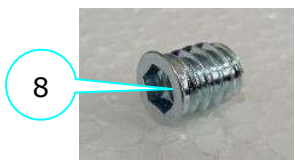
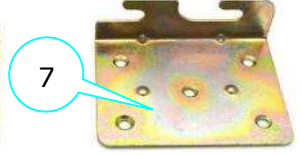
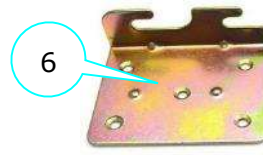
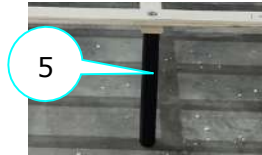
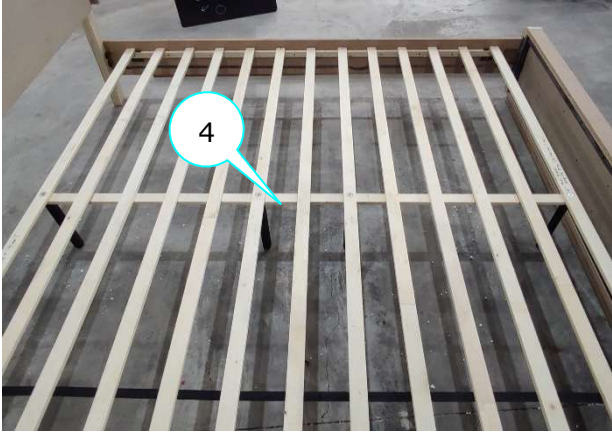

APPROVALS
