



REPLACEMENT PART DESCRIPTION FORM

MODEL #: B3381-81,99

PART#	DESCRIPTION	USED ON:	MRP#	FOB \$	MATERIAL	QTY.	FACTORY USE ONLY!!	
							PACK	P/M
1	Side Rail (w/Hooks)(L=2053mm)	B3381-99	R84311		Wood 100% Polyester Cleaning Code: W	2	K	M
2	Headboard Leg (58x100x100mm)	B3381-81	R84313		Wood	2	G	M
3	Footboard Leg (58x58x100mm)	B3381-81	R84314		Wood	2	G	M
4	Slat Assembly (L=1544mm)/21pcs	B3381-81	R84326		Wood	1	K	M
5	Center Support Rail (w/Hooks)(L=2060mm)	B3381-99	R84316		Wood	1	K	M
6	Center Leg (w/Bolt+Leveler)(169x30x30mm)	B3381-81	R84319		Wood	4	G	M
7	Hook #1 (w/Screws+Bolts)	B3381-99	R84329		Wood	2	G	P
8	Hook #2 (w/Screws+Bolts)	B3381-99	R84330		Wood	2	G	P
9	D-Nut (5/16in x 15mm)	B3381-81	R76141		Metal	4	G	P
10	D-Nut (5/16in x 25mm)	B3381-81	R43690		Metal	8	F	P
11	D-Nut (1/4in x 15mm)	B3381-81	R77634		Plastic	4	G	P
12	D-Nut (M6 x 15mm)	B3381-99	R68415		Metal	8	G	P
13	Bolt Pack	B3381-99	R84321		M6x15mm Allen Bolt (8)	1	G	P
14	Adjustable Leveler (M6x20mm)(D=22mm)	B3381-81	R84322		Plastic+Metal	4	G	P
15	L-Bracket (w/Screws)(33x23x22mm)	B3381-81	R84323		Metal	2	G	P
16	U-Bracket (w/Screws)(85x23x1mm)	B3381-81	R84324		Metal	2	G	P
17	Hardware Pack	B3381-81	R84325		5/16inx1 1/4in Allen Bolt (8) 5/16in Flat Washer (8) 5/16in Lock Washer (8) 1/4in x 2 3/4in Allen Bolt (4) 1/4in Flat Washer (4) 1/4in Lock Washer (4) M10 x 30 Wood Dowel (4) M4 Allen Key (1) M5 Allen Key (1)	1	G	P

REPLACEMENT PART DESCRIPTION FORM
MODEL #: B3381-81,99

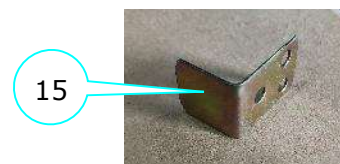
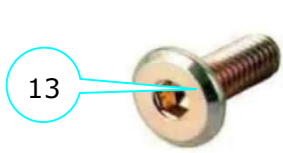
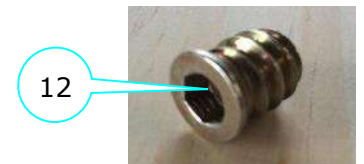
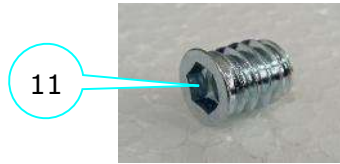
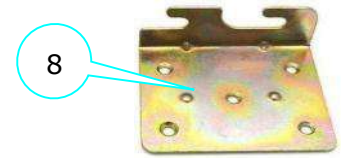
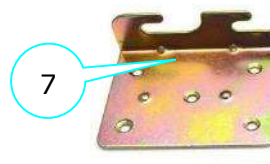
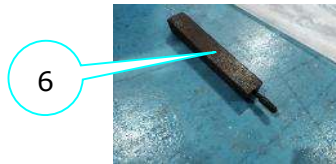
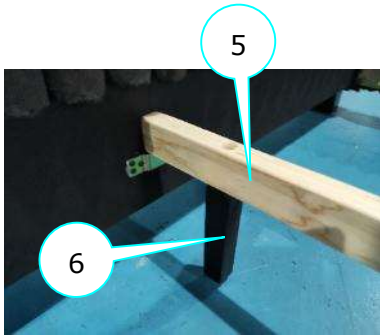
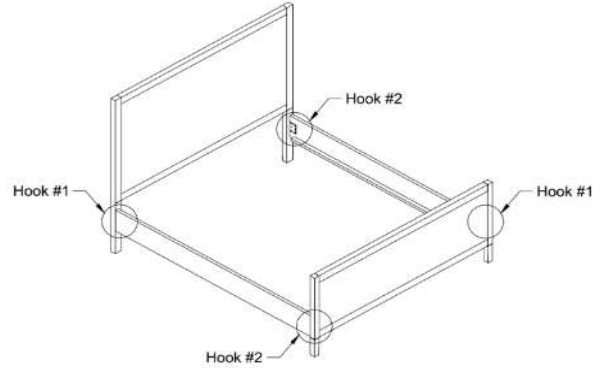

APPROVALS

--	--	--